



## PRODUCT HANDLING

---

## VARIETY TO PERFECTION

---

Product handling represents the link between the individual process steps. Glatt has recognized the growing importance of this link by establishing various new product lines that are custom-designed for the requirements of our clients and can be applied to a multitude of product handling tasks.

Glatt is capable of supplying an extremely wide range of system components, ranging from a single lifting device through to the equipment for a fully automated factory. Whether for weighing, dosing, mixing, sieving, transport, storage, or docking – both manual and automatic – Glatt offers the optimum solution for every requirement.

A high level of flexibility coupled with customer input provide the base for meeting all of our customers' requirements. Glatt is proud both of its ability to supply custom-made systems and equipment and of its skills in implementing complete turnkey solutions. Close cooperation with our customers from the start guarantees the successful completion of our projects. Providing outstanding after-sales service is another part of Glatt's recipe for success.

**Customers today want integrated systems – ideally from a single source. The main design criteria for a product handling system are determined by material flow, degree of automation, and level of containment.**



Glatt granulation line with handling equipment



**Glatt granulation line with handling equipment**

It is during the planning phase that the foundations for future success are laid. As a result, Glatt not only offers individual components with full support right from the concept and planning phases – it is also possible to integrate existing systems and equipment into this overall concept.

Glatt's experience is based on the successful completion of numerous major projects.



**Handling equipment for product transfer from container to tablet press**



## VERTICAL MATERIAL FLOW PRINCIPLE

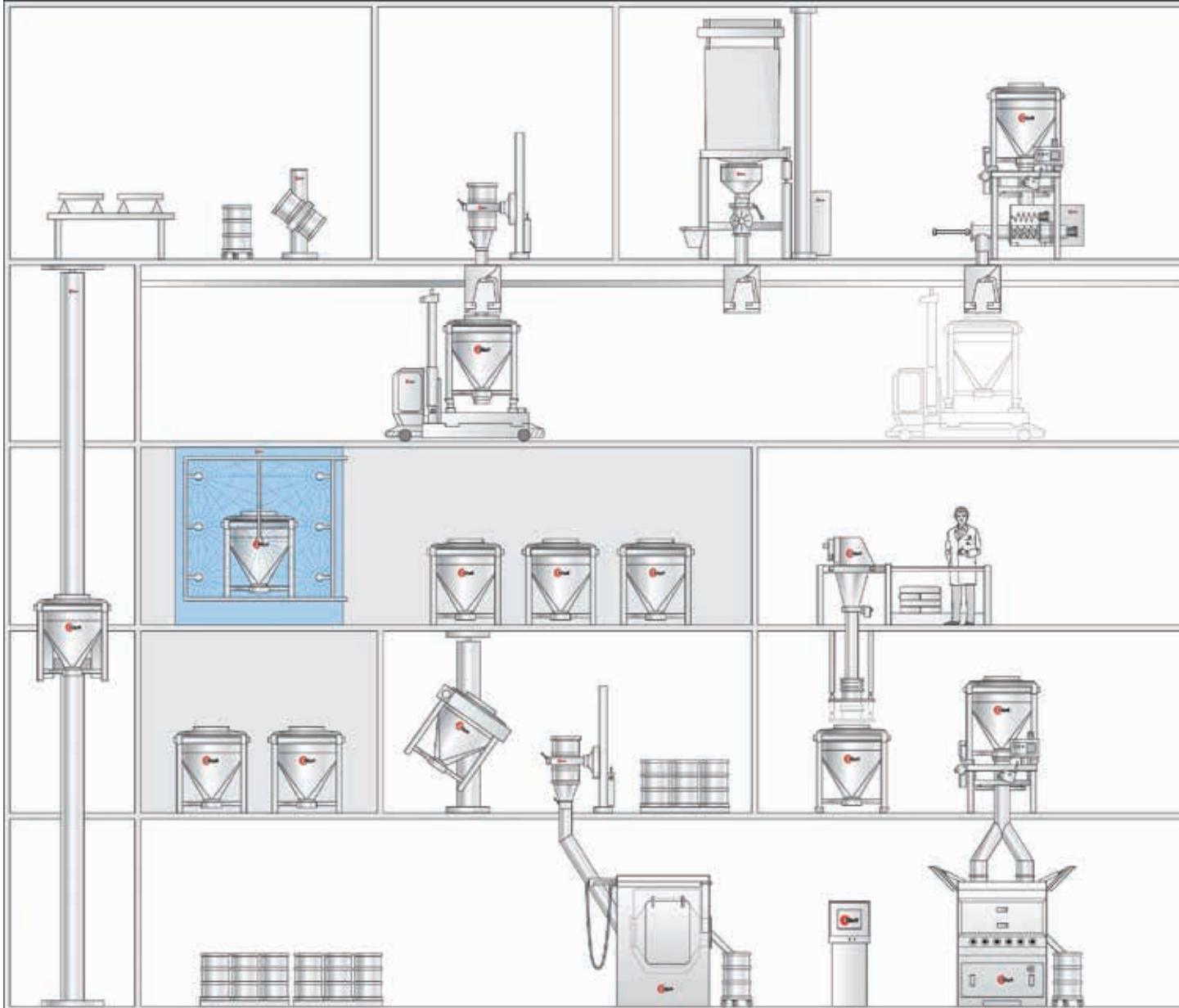

### *Vertical processes on different levels.*

The vertical arrangement involves product flowing predominantly downward through several levels driven by gravity. The individual process steps are either linked together directly or interconnected by the use of Intermediate Bulk Containers (IBC) with docking stations for filling or discharging. With IBCs and docking stations, it is possible to freely select the sequence of the various process steps.

### **Quality down to the last detail with high-quality components.**

All Glatt handling components are manufactured to a very high level of quality. We offer advantages such as GMP-compliant stainless steel construction, high functionality, and an easy-to-clean design. The use of certified pharmaceutical grade materials is standard. The high level of quality is guaranteed by our skilled workforce and our demanding internal acceptance criteria.

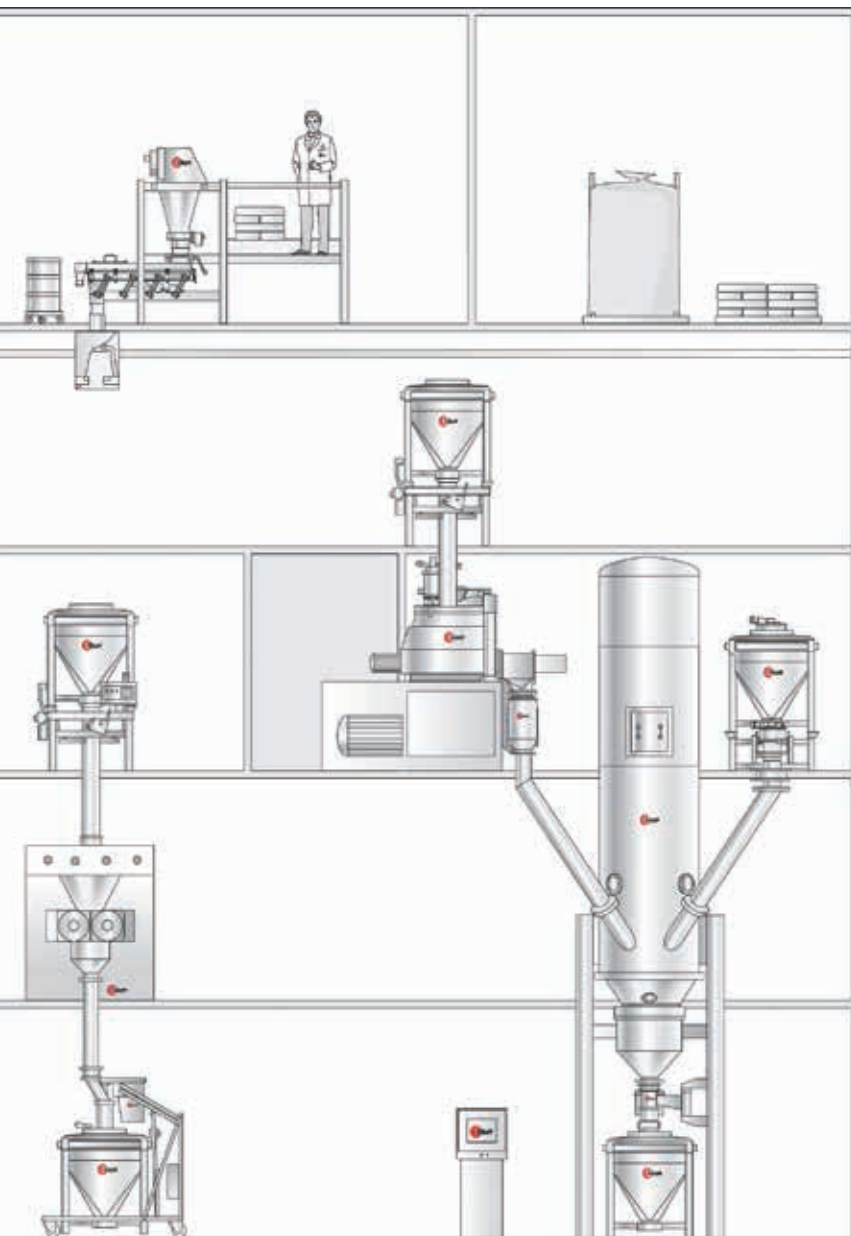

**The question of the basic process layout dominates the planning and configuration of how the main process steps (e.g. granulation, drying) are linked together by essential product handling operations.**

**Customized according to personal requirements:**

**The latest in control systems and data management.**

The scope of process control ranges from straightforward local manual operation through to complete process automation using programmable logic controllers and PC systems. Furthermore, it is possible to integrate many different functions for recipe management, data acquisition and data monitoring via networks.

## HORIZONTAL MATERIAL FLOW PRINCIPLE

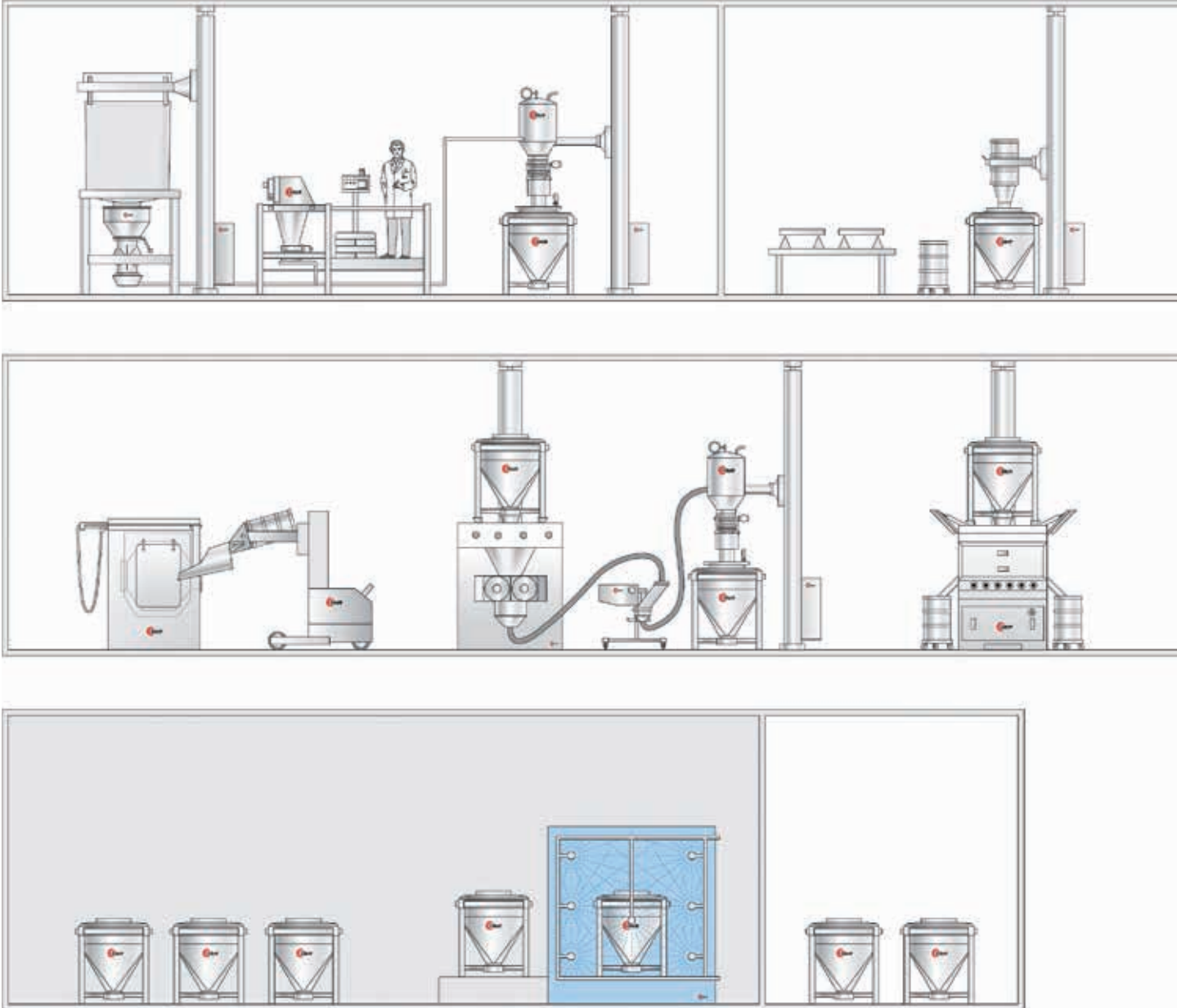

### *Horizontal processes on one level.*

In a horizontal process layout, both vacuum transport and / or gravity are used to induce product flow. Pneumatic conveying systems are employed in many of these applications, as well as mobile and stationary lifting and discharging devices.

The flexibility provided by a horizontal arrangement of process components allows rapid product changes and an infinite variety of process configurations.

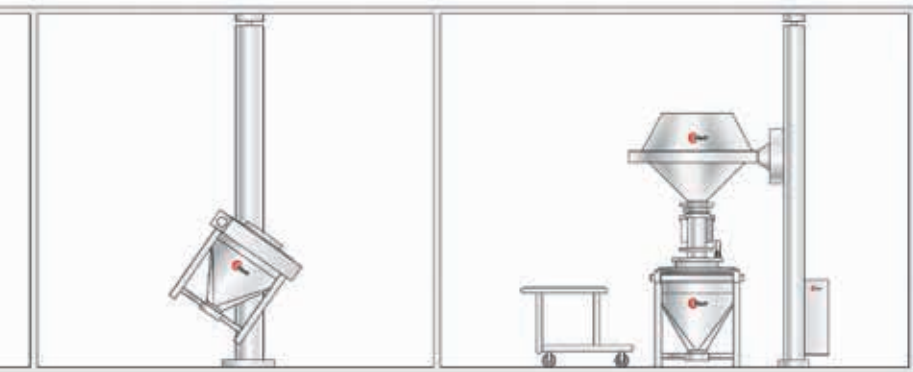
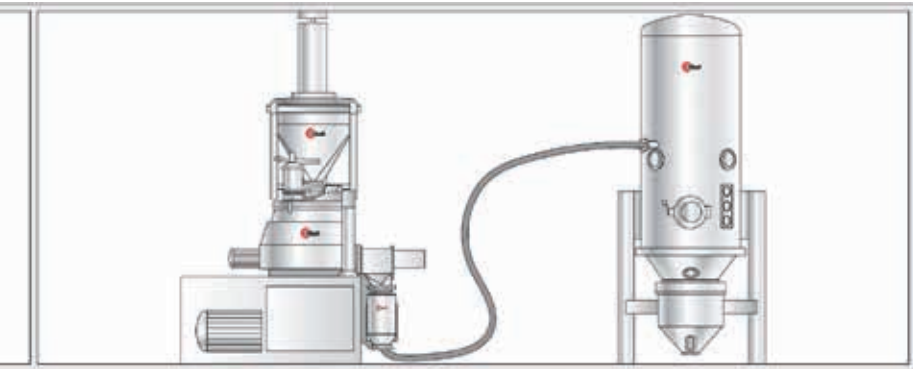

## Contents

	Page
Variety to Perfection	2
Vertical Material Flow Principle	4
Horizontal Material Flow Principle	6
Lifting, Discharging and Transport Systems	8
Container and Drum Blenders	10
Intermediate Bulk Containers	12
Pneumatic Conveying Systems	13
Filling and Discharging Systems	14
Docking Systems	15
Containment Valve System TKS	16
Large Component Weighing Systems	18
Small Component Weighing Systems	20
Dispensing and Dosing Systems	21
Washing Systems	22
Data Management and Documentation	23

## LIFTING, DISCHARGING AND TRANSPORT SYSTEMS

*Lifting. Positioning. Transport.  
Turn and rotate as needed.*

Glatt boosts the efficiency and mobility of your handling systems! We provide a range of equipment for modern and effective product handling that includes a great variety of mobile and stationary lifting and discharging devices.

### The classic applications are

- » Simple horizontal or vertical transport
- » Positioning for filling and discharging of containers, drums, big-bags (super sacks), and product bowls for fluid bed machines
- » Positioning of equipment (e.g. sieves, pneumatic conveying systems)



**Container Blender CM 400 for transferring from IBC into IBC**



**Swivelling lifting device L 1500 for discharging containers into a vertical granulator VG 600**



**Lifting and discharging device LD 120 with cone on trolley**



**Lifting device ELD 60 for discharging containers into a coater**

### Mobile or stationary – it's your choice.

Glatt offers a wide range of equipment to meet any requirement. The standard product line includes stationary lifting equipment with payloads of up to 2,500 kg as well as mobile lifting and transport equipment with payloads of up to 1,200 kg.



If there are restrictions due to door heights, mobile lifting devices with telescopic columns provide a convenient solution.



Mobile drum inverter MEL 300 with discharge cone



EL 600 lifting device for discharging drums through a GS 180 rotor sieve



Height-adjustable container trolley for product transfer



Container trolley for transport

**Glatt always finds a solution to save costs and time, no matter how tricky the task. Standardized, yet compatible with a wide range of handling equipment.**

## CONTAINER AND DRUM BLENDERS

*Thorough mixing. Homogenizing.  
Ideal distribution of active  
ingredients and additives.*

In the processing of powder and granules, batch blending represents an important process step. Through storage, transport, or weighing – all the active ingredients, additives, and raw materials in the IBC have to be converted into a homogeneous mixture as quickly and effectively as possible.

**Glatt has an appropriate ATEX compliant blender for all requirements, for both containers and drums. All Glatt blenders are easy to integrate into process lines and quick and simple to load. Furthermore, all Glatt blenders operate quietly thanks to their pneumatic or mechanical clamping devices.**

### KCM container blender series

- » For rectangular / square IBCs from 100 l to 2,000 l
- » For drums up to 200 l
- » Low-noise blending process through reliable fixing of IBCs by means of mechanical clamping or drums using manual or mechanical clamping
- » Quick tilting of the IBC or drum into the blending position
- » Rapid blending results through optimum positioning of the IBC or drum
- » Constant speed and direction of rotation

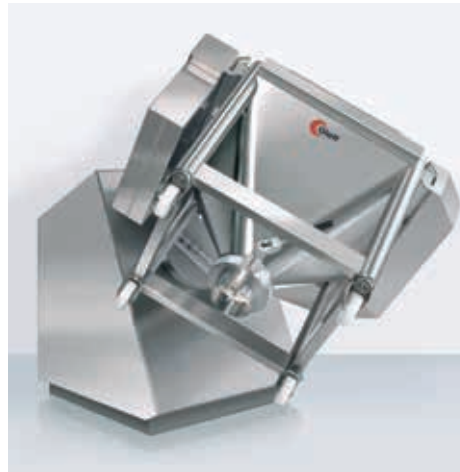

**Tilting container blender KCM 800**



**Container blender CM 400 with manual clamping**



**Tilting drum blender KFM 200**

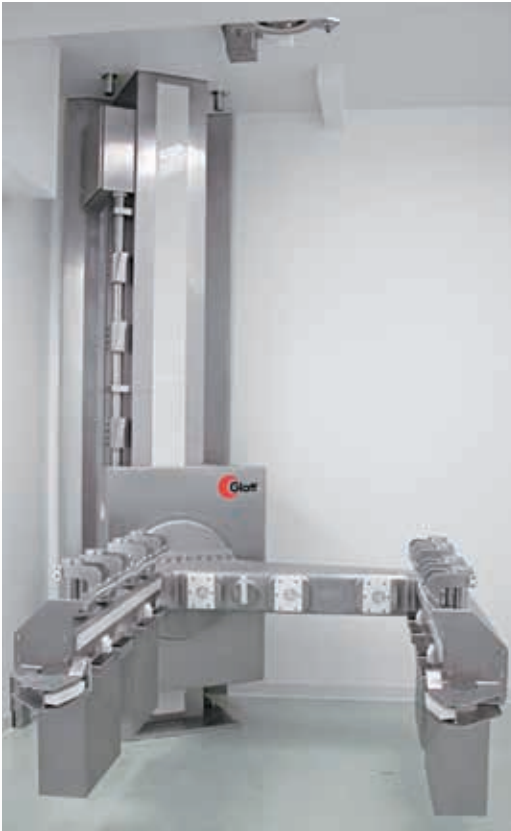

Container blender CM 2500 with pneumatic clamping

## CM container blender series

- » For rectangular / square IBCs from 100 l to 2,500 l
- » Low-noise blending process through reliable fixing of IBCs by manual or pneumatic clamping
- » Rapid lifting of the IBC into the blending position
- » Ideal, thorough mixing by rotating the IBC in its clamping arm; the product is diverted by the IBC corners
- » Variable speed and direction of rotation on the IBC
- » Combines the advantages of the lifting device and IBC blender
- » Suitable for additional process steps (e.g. sieving & milling)



Container blender CM 1200 with manual clamping and various IBCs

## INTERMEDIATE BULK CONTAINERS

*Effective. Practical. Flexible.  
Reliable transport of product  
and information.*

Weighing, mixing, storage, transport, and documentation. Glatt offers a complete range of stainless steel containers for powders, granules and tablets, which are simultaneously carriers of product and process information. The extensive family of containers includes a comprehensive range of cross sections – rectangular, square, or round.

### **Standardization through modular design.**

Based on the close cooperation with our customers and many years of experience, Glatt has developed a standardized modular design concept for IBCs.



Containers can be supplied as self-supporting structures or with a rigid frame, depending on the specific requirements.



### **All options are available, according to the particular application**

- » Stacking capability
- » Fork channels
- » Skids for roller conveyor transport
- » Filling lid
- » Quick release
- » Filter
- » Discharge valve
- » Discharging supports
- » Vibrating support
- » Batch documentation



**The Glatt Intermediate Bulk Container has proved its value as a systematic link between the individual process steps.**



## PNEUMATIC CONVEYING SYSTEMS

*Vacuum transport. Flexible.  
Direct linkage of processes.*

Glatt PCS systems can be used wherever process units and product carriers are filled and emptied. The same applies to direct transport between two process steps, especially on the same level. The pneumatic conveying systems are equipped with filters on the exhaust air side.

Glatt PCS pneumatic conveying systems are available in different sizes from the PCS 10 up to the PCS 1500 – these sizes refer to the nominal volume of the product separator in dm<sup>3</sup>. In addition to the standard PCS line, our pneumatic conveying systems are also available as SC-Super-Clean (Clean in Place, CIP), PRO (12 bar pressure shock-resistant) and ECO (simple and cost-saving) versions.

The pneumatic conveying systems can operate in connection with further equipment in both modes – batch or quasi-continuous.



PCS<sup>PRO</sup> 50 with swivelling lid for easy filter exchange



Pneumatic conveying system PCS 1500 with rotor sieve GS 180

**Glatt pneumatic conveying systems PCS make it possible to transport powders, granules, and other free-flowing solids by means of vacuum transfer, handling the substances gently.**

## FILLING AND DISCHARGING SYSTEMS

*Reliable. Low contamination.  
Flexible. The optimum solution  
for every process.*

Glatt filling and discharging devices are in demand whenever powdery substances have to be transferred into IBCs or process units without creating dust. Protecting people and preventing cross-contamination are the most important priorities here.

### **Modular systems make up the complex solution.**

With its modular filling and discharging systems, Glatt is in the best possible position to meet individual customer requirements.



**Container discharge station CDS with weighing**



**IBC charging**



**Raw material dispensing with sack discharge into an IBC**

## DOCKING SYSTEMS

*Low dust levels. Safe. Reliable.  
Manual and automatic.*

Dust must not be allowed to escape into the environment during the filling and discharging of powders and granules. As a result, docking devices which operate with total reliability are essential for low-dust product handling. All docking elements have been developed by Glatt in accordance with the required "level of containment".

### As a rule, the following docking elements are used for filling and discharging product receptacles and process systems

- » Silicone collar, tulips, and expansion joints for pipe ends and flanges
- » Static seal with docking / lifting device
- » Contact-free docking system
- » Inflatable radial and axial seal
- » Docking with containment valve system TKS (see page 16)

### Clean filling and discharging with minimum dust.

#### Charging

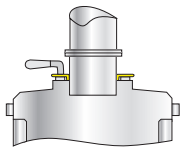

Silicone collar with adapter pipe

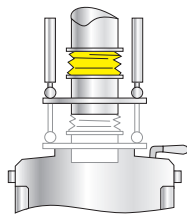

Static seal with pneumatic lifting device

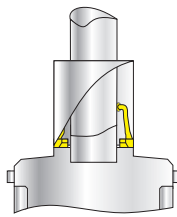

Contact-free docking system

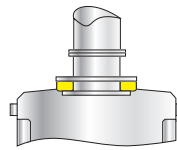

Inflatable radial seal

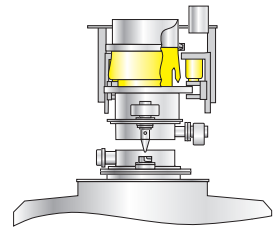

Glatt containment valve system TKS

#### Discharging

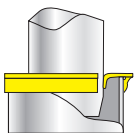

Silicone collar

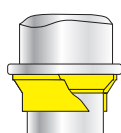

Tulip shaped docking collar

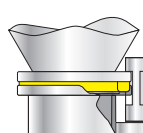

Inflatable axial seal

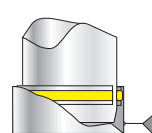

Inflatable radial seal

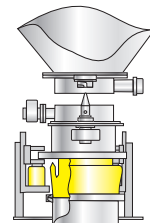

Glatt containment valve system TKS

#### Perfect solutions.

Additional components which complete the docking system and contribute to operation with minimum dust include: positioning elements, ceiling pass-through elements and local dust exhaust systems, self-cleaning chute covers, and various cleaning accessories. Glatt offers all these elements with the standard high level of quality.



Docking system using an inflatable radial seal, before docking



Docking system using an inflatable radial seal, docked

## CONTAINMENT VALVE SYSTEM TKS

*Ecological. Economical. Automatic.  
Patented total containment solutions.*

High-potency substances in research, development, and production require highly effective safety precautions for humans, the environment, and products. Glatt presents the Containment Valve System TKS with two identical static seals. In combination with custom-made docking systems, Glatt offers various solutions for handling solids by maintaining minimum emission limit values. Our ambition is to implement technically and economically optimized solutions for our customers, their product developments, and production. With many proven and patented solutions and closed collaboration with users worldwide, our Containment Valve System emphasises these efforts.

The technical principle and detailed design of the Containment Valve System TKS not only meet the requirements for transferring solids with an Occupational Exposure Limit (OEL) < 0.1 µg/m<sup>3</sup>, it likewise simplifies installation, cleaning, and maintenance.



TKS passive valve half and automatic active valve half

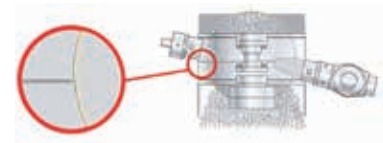
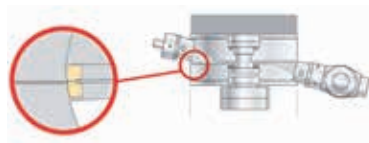
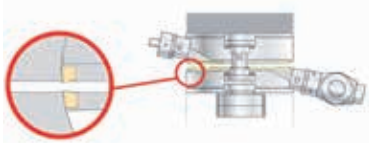

- » Positioning the IBC
- » Docking the passive valve half onto the active valve half guided by locking pins

- » Locking both valve halves by rotating the locking pins

- » Opening the valve
- » Product transfer from one closed system to the other
- » Closing the valve after product transfer
- » Unlocking and undocking both valve halves

Operating principle of Glatt series containment valve system TKS



## The unique valve system TKS

- » Full operator protection
- » No cross-contamination or product contamination
- » Single-side mounted, single-piece valve shaft
- » Guaranteed error-free function & assembly without tools
- » WIP/CIP-able
- » cGMP-compliant design
- » Quick and easy disassembly / reassembly
- » Flexible, manual, or fully automated operation

## A complete setup for integration into a docking station consists of

- » One active valve, incl. pneumatic actuators for locking and opening / closing of the valve
- » One docking module, incl. float-mounted system and connection of product chutes to the filling / discharging equipment
- » One PLC control system for controlling the docking and opening / closing sequences of the valve



Automatic active valve half on active docking system with automatic lifting



Mobile docking station



Charging into a granulator via TKS



Direct product transfer via TKS

## LARGE COMPONENT WEIGHING SYSTEMS

*Productive. Product line-oriented.  
Safe and flexible.  
Manual or automatic  
raw material weighing.*

Raw materials required in large quantities are added to the process from storage receptacles such as big-bags (super sacks), sacks, drums, or cardboard boxes. This may involve direct addition to the process system or it can also be indirect, with prior dispensing into IBCs. In most cases, large quantities of several raw materials are weighed and added to the batch container or drums at frequent intervals with a settable degree of precision.



**Weighing system incl. dosing**

### Weighing systems

- » Very high level of safety for operators and the product
- » Automatic weighing with high productivity
- » Incorporation of adding stations for "pre-mix" and small components
- » Raw material identification and verification
- » Recipe management
- » Interface to production management system
- » Automatic process and batch documentation



**Automatic weighing and charging of IBCs**



Raw material dispensing from sacks, big-bags and IBCs



Combined raw material dispensing from big-bags and sacks into ICBs

### Weighing stations and cabins

- » Manual or automated with high precision
- » Direct weighing from packings
- » Weighing log / manual process documentation
- » Safety check for raw materials
- » Operator information from the production management system

**The range of process equipment available includes everything from manually operated single weighing stations through to fully automated weighing systems. Glatt also offers complete solutions for every application.**



## SMALL COMPONENT WEIGHING SYSTEMS

*Precise. Reproducible. Safe for the operator.  
High containment level thanks to laminar flow or glove boxes.*

All batch information is checked carefully before each weighing procedure. The documentation is prepared after the weighing process. Glatt offers compact and easy-to-use small component weighing systems for different weighing ranges and tolerances.



**Isolator with weighing unit  
and discharge via containment  
valve system**



**Combined weighing system  
with sack and drum handling**

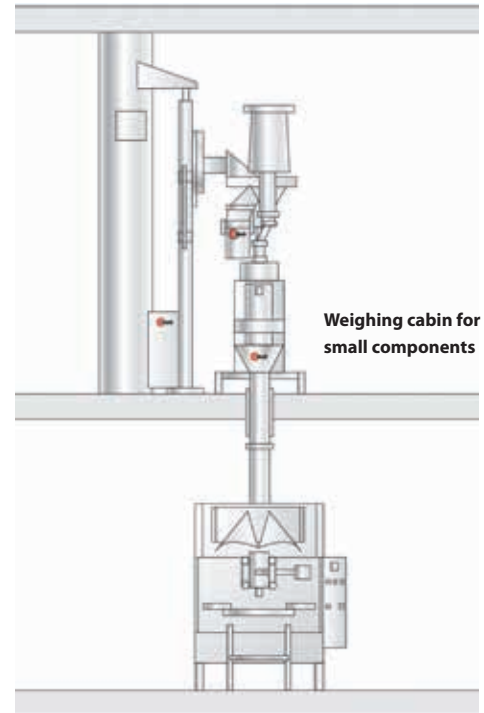

**Automatic weighing and filling system  
for small portions into plastic bags**

### Addition of small components to containers

- » Rapid product change thanks to replacement of parts which come into contact with the product
- » Exact product identification and checking
- » Display and activation of safety functions in cases of non-conformance
- » Addition to the container in "pre-mix" format or as active ingredients / additives

**The increasing complexity of formulations is leading to a situation in the powder and granule processing industry where more and more constituents comprising small quantities of active ingredients, additives, colorings etc. have to be added to the base carrier materials.**



## DISPENSING AND DOSING SYSTEMS

*Safe. Clean. Accurate.  
With maximum precision.*

Glatt offers a wide range of dosing devices for low dust and, if required, automated dosing into product transport and storage receptacles as well as into process systems. The dosing range for powders and granules extends from a few grams to several thousands of kilograms per hour, with the usual high level of precision. The guaranteed dosing accuracy forms the basis for sustained repeatability in recipe formulations. Glatt also integrates commercially available dosing systems from other manufacturers.



Transfer / Dispensing station

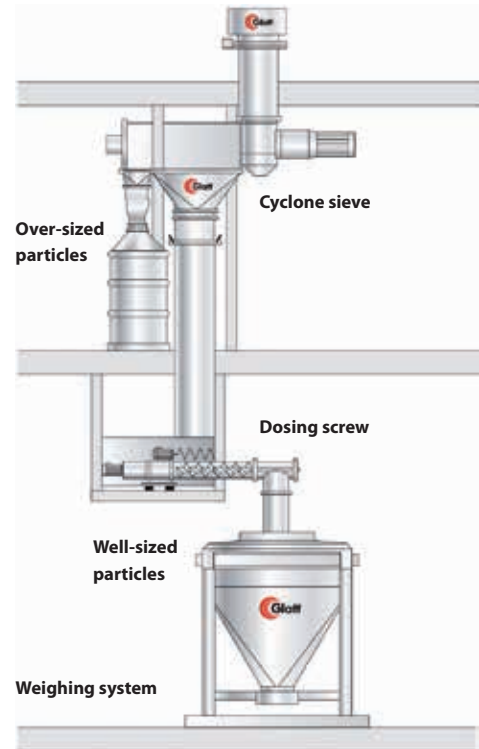

Dosing system with integrated cyclone sieve and dosing screw

### Dosing screw

- » Consistent dosing and product transport
- » Throughput from a few  $\text{cm}^3$  per hour to several  $\text{m}^3$  per hour
- » High dosing accuracy (depending on size and product)



Mobile dosing screw

## WASHING SYSTEMS

*Washing. Drying. Cooling.  
Product-specific with clean solutions.*

Manual or fully automatic washing? The trend in cleaning process systems is increasingly moving towards fully automated cleaning. As a result, Glatt has developed special solutions for cleaning IBCs, which can be adapted to specific technical and structural conditions. The variety of systems ranges from simple manual washing stations to validated, fully automatic washing, drying, and cooling stations built as single or multiple cabins, together with the associated preparation systems for washing solutions.



Automatic single cabin washing machine CWM with IBC



Parts washing machine PWM, container washing place CWP and container washing machine CWM

### Single cabin and multiple cabin washing systems

- » Washing and drying / cooling in separate cabins arranged in series or side-by-side
- » Up to 20 containers per shift
- » Automatic container transfer
- » Valves open and close manually / automatically in the cabin
- » Automatic selection of washing recipe based on the container ID
- » Washing recipe management and washing process documentation

### Supply units for washing systems

- » Washing solution recipe and washing cycle can be determined according to the last product in the container
- » Separate handling in a glove box
- » Provision of solution for pre-cleaning
- » Provision of deionized water (hot or cold)
- » Provision of washing solution



Cleaning station CVSI 06

## DATA MANAGEMENT AND DOCUMENTATION

*Automation. Validation.  
Documentation.  
Secure and reliable data  
management.*

The increasingly demanding requirements for control, monitoring, and data management systems are determined by regional and company-specific regulations, rules, and standards.

The specialists at Glatt develop, plan, and supply complete control and information system packages specifically tailored to the customer's requirements. The increased demand for reproducible processes makes it necessary to document all processes and equipment, and prepare all relevant data within a logical structure.

**The modern data acquisition and documentation system from Glatt helps customers to address their planning and production tasks. Process information such as recipes and operating data for machines and plants can be automatically uploaded and evaluated.**



Control system including operating and data management



Qualified training programs at our in-house Technology Center TTC



Structured documentation of processes and equipment

### Validation stages and support

- » **Design qualification (DQ)**  
Specifications and test schedules according to the customer's requirements
- » **Installation qualification (IQ)**  
Completeness of equipment and correct installation
- » **Operation qualification (OQ)**  
Correct functioning of the equipment and functioning of the system in defined working areas
- » **Performance qualification (PQ)**  
Reliability of equipment



[www.glatt.com](http://www.glatt.com)